

POWER AND MODULAR SOLUTIONS

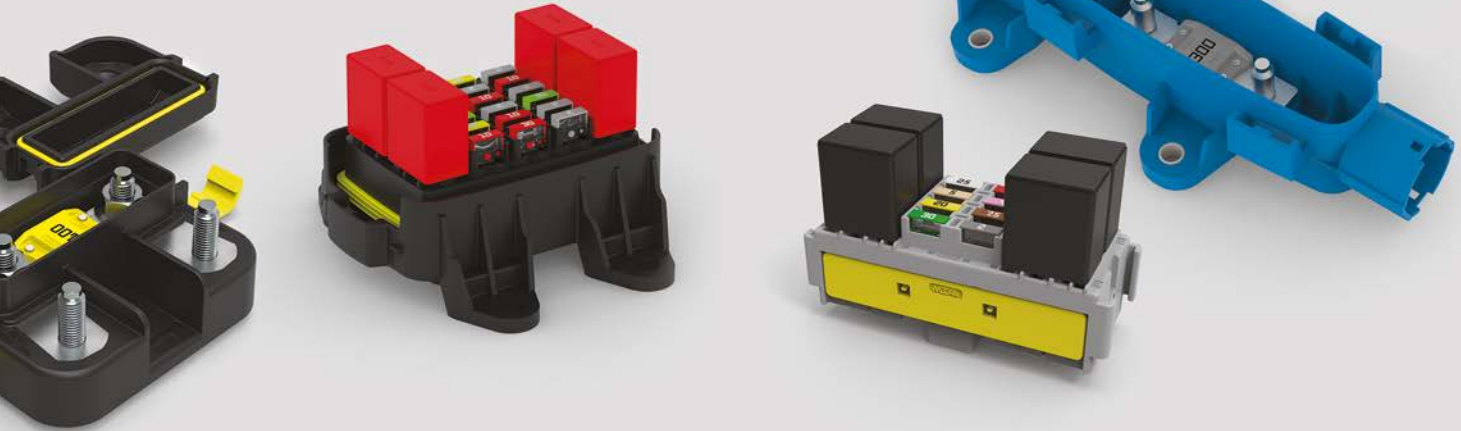

UTMOST VERSATILITY AND RELIABILITY

Designated for heavy duty power distribution and main electric services protection, these Power Distribution Units, Modular Electrical Centers and Frames with modules, are developed based on a modular design concept for the utmost versatility.

They have been updated to deliver higher performance and respond to the new demands of these applications. They permit a simplified wiring harness layout in the engine bay to keep harnesses safe from water and dirt.

Some PDUs have been developed and produced to be suitable for 48 V electrical architectures to support the most energy-demanding systems.



CARS



TRACTORS



OFF-HIGHWAY
VEHICLES



MOTORCYCLES



TRUCKS



E-MOBILITY



Read more about MTA power and modular solutions on
www.mta.it/en/electrical-products

SMART FUSE BOX

Smart Fuse Box is an intelligent power distribution unit, designed for agricultural, off-highway vehicles and buses. The ECU can be used to drive, protect and monitor up to 30 loads, through the eFuse, and to interface analog/digital signals and loads via CAN.

MAIN ADVANTAGES

- Size reduction (one device in place of fuse + relay).
- Serviceability: no need to access the ECU.
- Superior handling of loads with high current peaks and finer diagnostic.
- Reduced current consumption to control loads.
- Smoother switching without duty cycle limitations.
- No mechanical contacts.



HIGH VOLTAGE POWER DISTRIBUTION UNITS

MTA develops and produces HV PDUs, both for 400 V and 800 V rated systems: from the main disconnection unit, provided with high voltage contactors and placed inside the battery pack that disconnects the battery from the rest of the vehicle, to the secondary high voltage fuse-boxes for the auxiliary devices, to specific critical line management units like fast charge disconnection units. HV PDUs can integrate electric power devices and electronic controls or sensor management devices, with different communication possibilities to the vehicle system. They are plug & play components and meet all state-of-the-art requirements and specifications.



HIGH
VOLTAGE

EXAMPLES OF AVAILABLE FEATURES

- Plastic or aluminium case (depending on location in the vehicle and EMC shielding needs).
- Sealing systems up to IP6K9K.
- Ceramic sealed chamber contactors to meet very high current demands in reduced space.
- High voltage fuses and pyro-fuses to protect each single output line.
- Copper, aluminium, rigid and flexible busbar technologies.
- Shielded high voltage connectors and pass-through wire connections.
- Single and multiple loop HVIL internal circuits including HV connectors and lid switches.
- Air and liquid cooling plate systems.
- Diagnostic electronic modules based on internal temperature, voltage and current sensors.
- Cybersecurity compliant software.

FUSE HOLDERS & MULTIPLE FUSE BLOCK

This range of fuse holders can be used stand-alone or can be clipped together to form a multiple fuse block with busbar. They accept MidVal, MegaCompact and MegaVal fuses.



MIDIVAL
HOLDER



MEGACompact
HOLDER



MEGAVAL
HOLDER



BATTERY DISTRIBUTION UNIT

This BDU features a casted battery terminal in Z Axis in 2 versions: left or right side. It has compact dimensions which make it versatile and easy to be placed. Accomodates 1 MegaVal fuse.

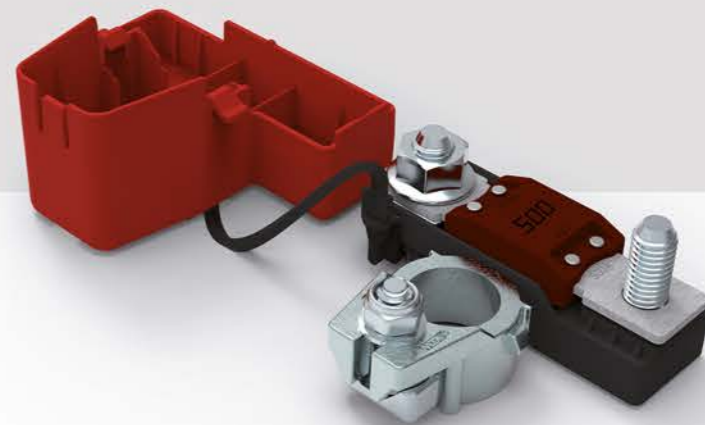

MEGAVAL HOLDERS  WATERPROOF

These fuseholders provide great resistance against bumping and tampering. A sealed separated compartment protects the fuse and terminations from harsh environments. The cover has a fixing system with positive touch and it is linked to the body by a tether to avoid possible loosing. One fixing point is located at the center while a second one is satisfied by anti-rotation device on the main body, thus the possibility to fix the fuseholders in different positions.

Two versions available: one with cover and gasket to seal the fuse compartment, the other with "extended" cover to protect the 2 stainless screws too. They can accommodate MegaVal fuses up to 500 A.



MEGAVAL HOLDER  WATERPROOF

This new fuse holder has been studied to solve even the most critical room problems. The dimensions of this product are in fact reduced as much as possible, still assuring best performances in strength and water tightness. It is composed by an upper and lower body with silicon gasket, 2 grommets, 2 retainers and a closing sealing assurance with or without M6 fixing flange.



48 V MEGAVAL HOLDER

This 48 V MegaVal fuse holder has been developed with very high-performing characteristics. It has been put through a series of tests with the result to be qualified for applications under the wading depth of cars. It can accommodate MegaVal fuses up to 500 A.

 WATERPROOF

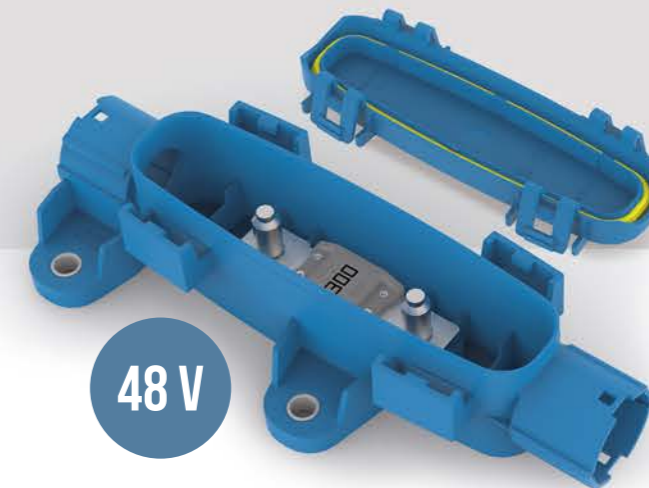



PDU 2M

 WATERPROOF

The PDU 2M is particularly indicated for harsh environments and in the presence of possible corrosion-related problems. Hence the choice of V2 grade materials in the body of the unit and the cover, external screws in stainless steel, increased degrees of protection and sealed separated fuse compartment.

The PDU is distinguished by the presence of a high-thickness copper busbar and breathable valve pressure relief mechanism.

The cover has a fixing system with positive touch and it is linked to the body by a tether to avoid possible loosing. The PDU has 2 fixing points allowing to fix the device in different positions. They can accommodate MegaVal fuses up to 500 A.

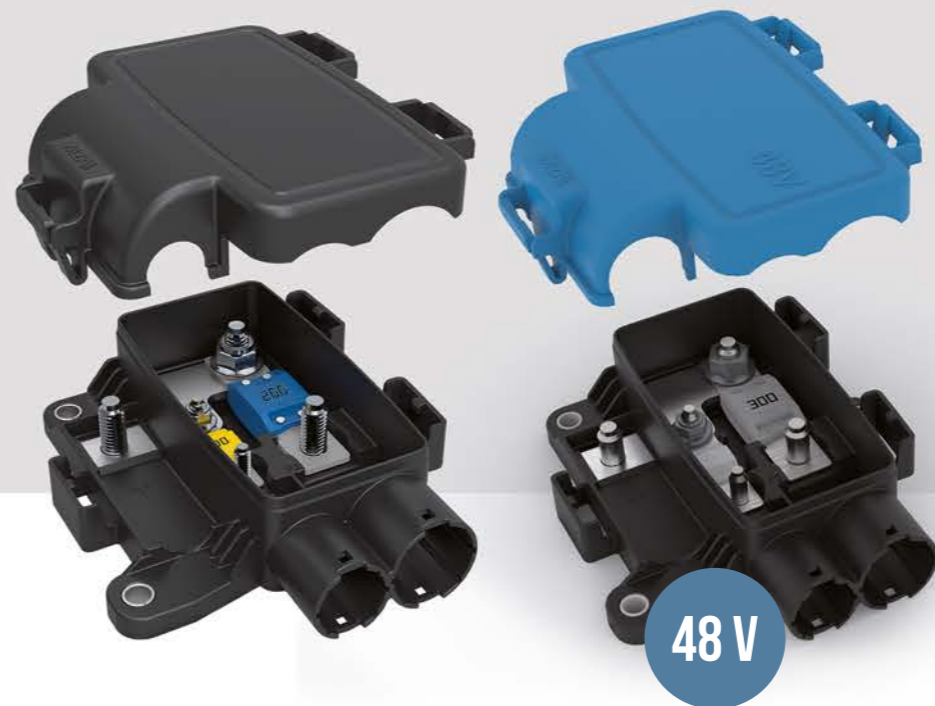
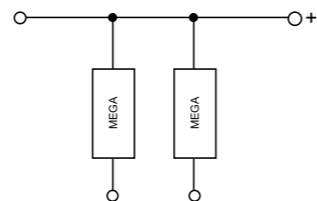

PDU 2-WAY

 WATERPROOF

Designed for both light vehicles and heavy-duty applications, these Power Distribution Units can accommodate MidiVal and MegaVal fuses.

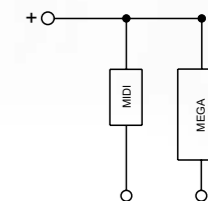

POWER DISTRIBUTION UNITS

PDU 3, 4-WAY

Thanks to their compact shape and multiple fastening points, these Power Distribution Units are versatile and easy to use. They can accommodate MidiVal and MegaVal fuses.



 WATERPROOF

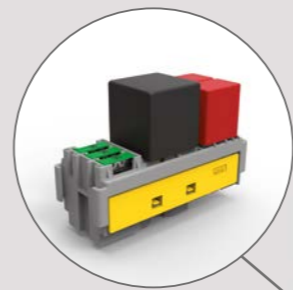
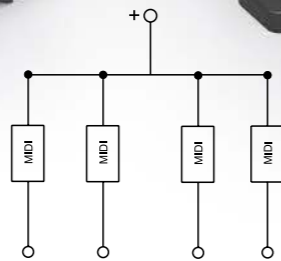
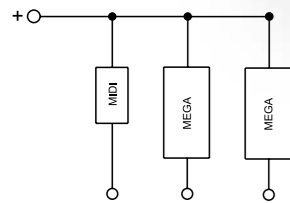

POWER DISTRIBUTION UNITS

CONFIGURABLE PDUs

These PDUs offer a high level of flexibility. They can house electronic BDS and different combinations of bussed MidiVal and MegaVal fuses (up to 4 MidiVal and 2 MegaVal). They can also accommodate 5 MiniVal fuses and any fuse and relay holder module in the MTA range. A seal mounted in the cover assures protection from dust and water.

 SPLASH PROOF

PDU 6 BDS

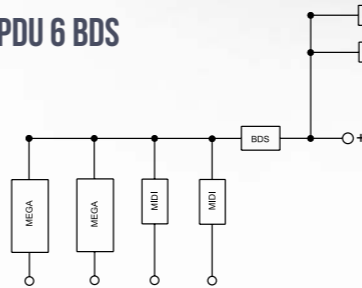

PDU 6

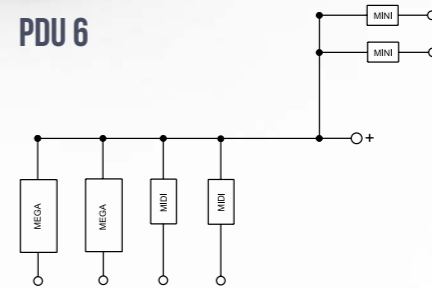

PDU 8

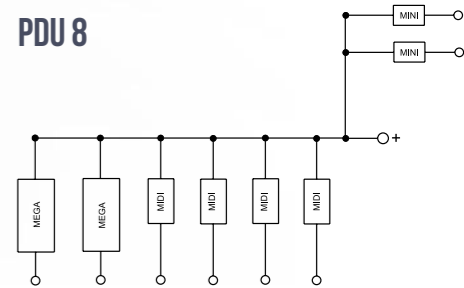

MODULAR ELECTRICAL CENTERS

Designed for the engine compartment, MEC 25 and MEC 97 are intended for the distribution of power and the protection of major utilities in agricultural and earthmoving machines applications. These Modular Electrical Centers are plug & play product with rational design and compact dimensions. They have a high level of customization, which can concern the fuses and relays; the inner mask; the PCB and the connectors depending from the needs of the users.

MEC 25



MEC 25 accepts 6 MiniVal fuses, 3 MidiVal fuses, and 5 MaxiCompact fuses (+2 spare).

MAIN FEATURES

- Press-fit technology.
- MEC 25 can be fixed in flat, inclined or vertical position.
- Appropriate latches preload the cover against the seal and close the MEC.
- The cover is tethered to the body to ensure it won't be displaced.

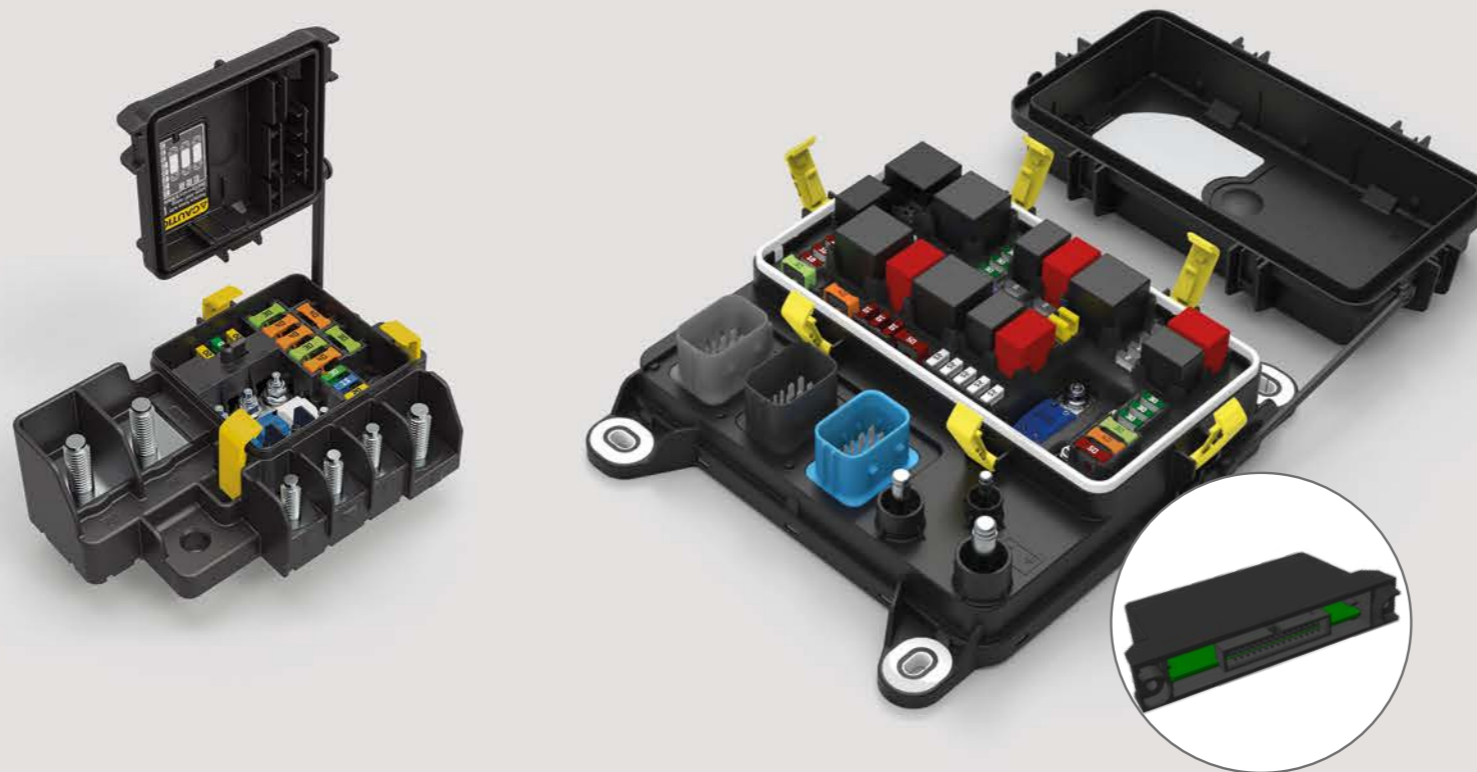

MODULAR ELECTRICAL CENTERS

MEC 97



MEC 97 accepts 3 MaxiCompact (+3 spare), 34 MiniVal (+3 spare), 1 MegaCompact, 1 MidiVal, 8 Micro relays, 5 Maxi relays.

MAIN FEATURES

- Press-fit technology.
- A Gore-Tex vent provides a barrier against water and dust and allows the free circulation of air, avoiding the formation of moisture.
- MEC 97 can be fixed in flat, inclined or vertical position.
- Appropriate latches preload the cover against the seal and close the MEC.
- The cover is tethered to the body to ensure it won't be displaced.
- Anti-vibration system integrated inside the fixing points.

CAN MODULE

The CAN Module Plug-in connects the MEC with the CAN Bus line to generate the actuations needed. At the same time, the Module, through the CAN Bus line, transmits the diagnostic information. The CAN Bus Module is configurable with MTA Studio, an in-house developed code composing tool.

MTA STUDIO

MTA Studio is a specific tool used to program dashboards, displays and electronic control units which have been developed with customizable functions allowing the customers to create "tailored" devices.

C-MEC 138

This Modular Electrical Center is a plug & play product with press-fit PCB allowing to integrate all the functions in one piece, this eliminating the need of different modules and associated wirings.

The C-MEC 138 is designed for installation in the cabin and has a high level of customization, which can concern the fuses and relays; the inner mask; the PCB and the connectors depending from the needs of the users.

It is ideal for new applications and for those who already use the MTA 5-way frame, with which it is interchangeable.

C-MEC 138 accepts 49 MiniVal fuses, 3 M8Compact fuses, 1 UniVal fuse and 1 shunt.

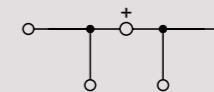
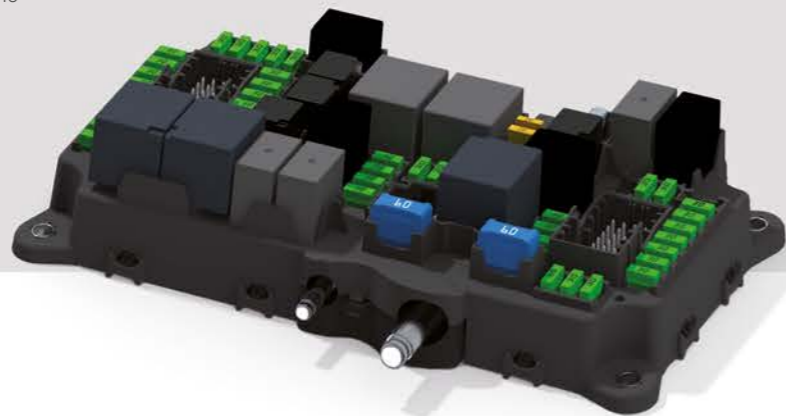

JUMP START NODES

These products provide a solution for rational safe multi-way electric power distribution. They are used to disconnect the electric system downstream of the battery. They have a special design that allows them to be adapted to each application.

Optional: a threaded middle pin which serves as a safe power connection to start up and/or charge external electric devices such as batteries or other equipments.

WATERPROOF MODULES

Vehicles operating around water and mud need advanced environmental protection. Our range of watertight modules has been developed to satisfy this need.

All terminals are equipped with a grommet and a radial silicone seal housed between the module and its cover keeps the modules secured tightly.

Modularity is the core philosophy behind these products: all modules can be used interconnected or stand alone and fixed with dedicated mounting brackets.

They can all accommodate fuses, relays, or both.



WATERPROOF

Accepts 30 MiniVal fuses or 10 Micro 280 relays or mixed relays and MiniVal fuses



Accepts 6 MiniVal fuses, 1 MaxiVal fuse, 2 Maxi relays and 1 Micro relay. Integrated mounting brackets version available.



Accepts 18 MiniVal fuses and 4 Micro relays. Integrated mounting brackets version available.



Accepts 6 MiniVal fuses, 1 MaxiVal fuse, 1 Mini relay and 3 Micro relays. Integrated mounting brackets version available.



MODULES

FRAMES, BRACKETS, COVERS & MODULES

We offer 15 modules and a variety of frames, covers, and brackets to build a wide range of flexible modular solutions for holding fuses, relays, or diodes. All of these products are equipped with secondary locks to guarantee maximum safety and high performance. They are built to resist stress and provide reliable technology.

RELAY RETAINERS

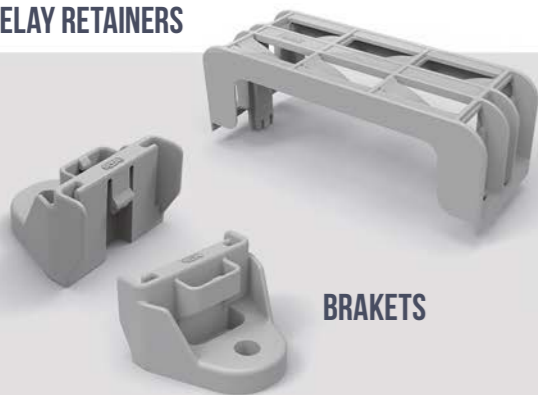

BRACKETS

COVERS

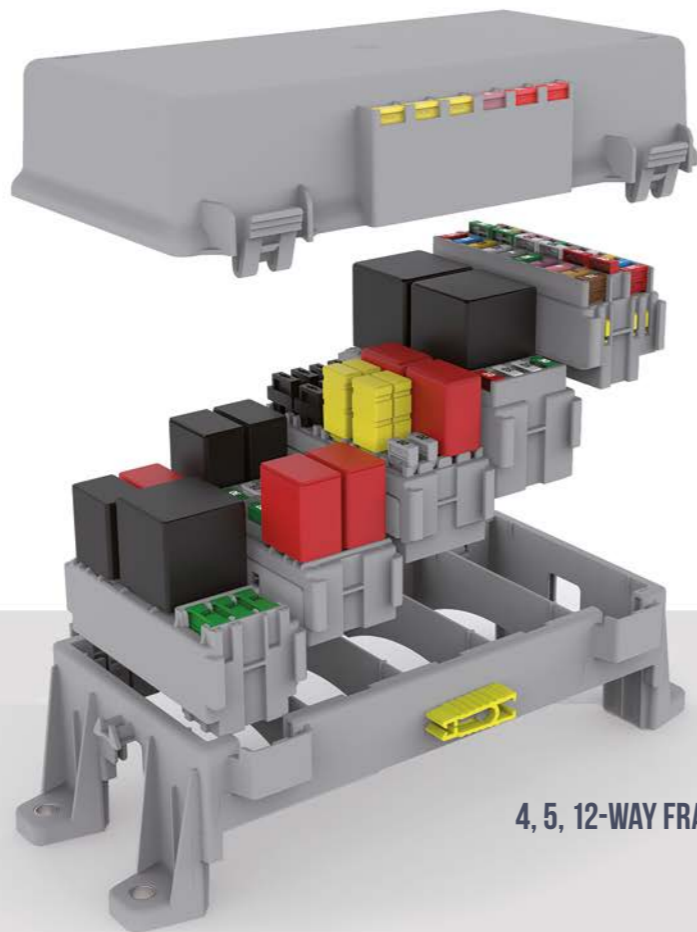

4, 5, 12-WAY FRAMES



Accepts 20 MiniVal fuses



Accepts 20 diodes
or 20 MiniVal fuses



Accepts 8 MiniVal fuses
and 4 Micro relays



Accepts 6 Micro relays



Accepts 1 Maxi relay
and 1 Mini relay



Accepts 2 Maxi relays

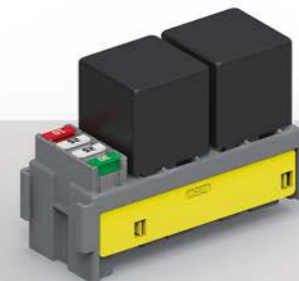

Accepts 4 MiniVal fuses
and 2 Mini relays

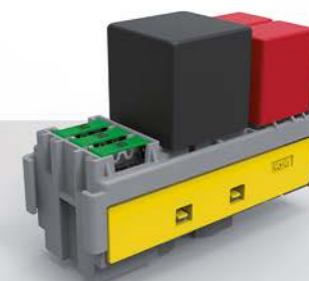

Accepts 3 MaxiCompact fuses,
1 Maxi relay
and 2 Micro relays

MODULES

MODULES



Accepts 6 MaxiVal fuses

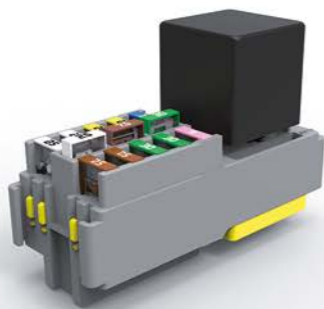

Accepts 10 MiniVal fuses
and 1 Maxi relay



Accepts 3 MaxiVal fuses
and 6 UniVal fuses



Accepts 4 MiniVal fuses
and 6 type A1 S fuses



Accepts 5 MiniVal fuses,
5 MaxiCompact fuses
and 3 M8Compact fuses

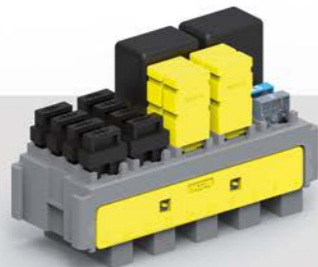

Accepts 20 MiniVal fuses
or 20 circuit breakers
or 20 diodes or 6 Micro 280 relays
or mixed

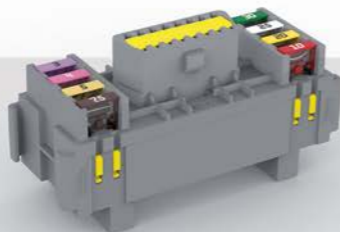

Accepts 8 MiniVal fuses
and 1 OBD connector

